

$\lambda = 10^\circ$
 $\gamma = 10^\circ$

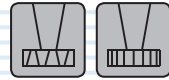

$D \leq 7,5$

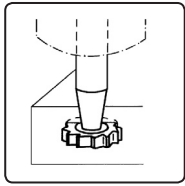

HSS
Co5

HSS
Co5

D h 12	S e 8	L	d h 6	Z	bxh DIN 6888	CODE 320005	CODE 320015	IDENT.
4,5	1	50	6	6	1x1,4	•	•	.045010
7,5	1,5	50	6	6	1,5x2,6	•	•	.075015
7,5	2	50	6	6	2x2,6	•	•	.075020
10,5	2	50	6	6	2x3,7	•	•	.105020
10,5	2,5	50	6	6	2,5x3,7	•	•	.105025
10,5	3	50	6	6	3x3,7	•	•	.105030
13,5*	2	56	10	6	-	•	•	.135020
13,5	3	56	10	6	3x5	•	•	.135030
13,5	4	56	10	6	4x5	•	•	.135040
16,5	3	56	10	6	3x6,5	•	•	.165030
16,5	4	56	10	6	4x6,5	•	•	.165040
16,5	5	56	10	6	5x6,5	•	•	.165050
19,5*	3	63	10	8	-	•	•	.195030
19,5	4	63	10	8	4x7,5	•	•	.195040
19,5	5	63	10	8	5x7,5	•	•	.195050
19,5	6	63	10	8	6x7,5	•	•	.195060
22,5*	4	63	10	8	-	•	•	.225040
22,5	5	63	10	8	5x9	•	•	.225050
22,5	6	63	10	8	6x9	•	•	.225060
22,5	8	63	10	8	8x9	•	•	.225080
25,5*	5	63	10	10	-	•	•	.255050
25,5	6	63	10	10	6x10	•	•	.255060
28,5	6	63	10	10	6x11	•	•	.285060
28,5	8	63	10	10	8x11	•	•	.285080
28,5	10	71	12	10	10x11	•	•	.285100
32,5*	6	71	12	10	-	•	•	.325060
32,5*	7	71	12	10	-	•	•	.325070



TiN

TiCN

TiAlN

Pokračování - Continuation - Fortsetzung - Продолжение

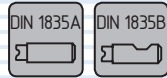
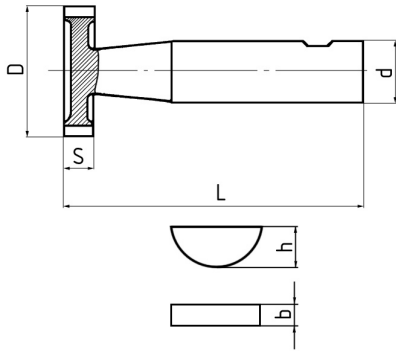

$\lambda = 10^\circ$
 $\gamma = 10^\circ$

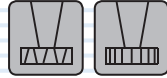

$D \leq 7,5$

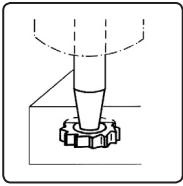
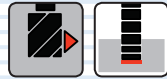

HSS
Co5

HSS
Co5

▼
Pokračování - Continuation - Fortsetzung - Продолжении

D h 12	S e 8	L	d h 6	Z	bxh DIN 6888	CODE 320005	CODE 320015	IDENT.
32,5	8	71	12	10	8x13	•	•	.325080
32,5	10	71	12	10	10x13	•	•	.325100
38,5*	8	71	12	10	-	•	•	.385080
45,5*	8	71	12	12	-	•	•	.455080
45,5	10	71	12	12	10x16	•	•	.455100

* / ≠ DIN 850



TiN

TiCN

TiAlN